

PHYSICS, TECHNOLOGY AND THE KNOWLEDGE ECONOMY

by

R. Chidambaram

*Foundation Day Lecture, Raja Ramanna Centre for Advanced
Technology, Indore, 19th February, 2013*

Physics-based Technologies

**They are among the most
Knowledge-Intensive**

&

**RRCAT has been structured for
the development of such
technologies**

Raja Ramanna Centre for Advanced Technology

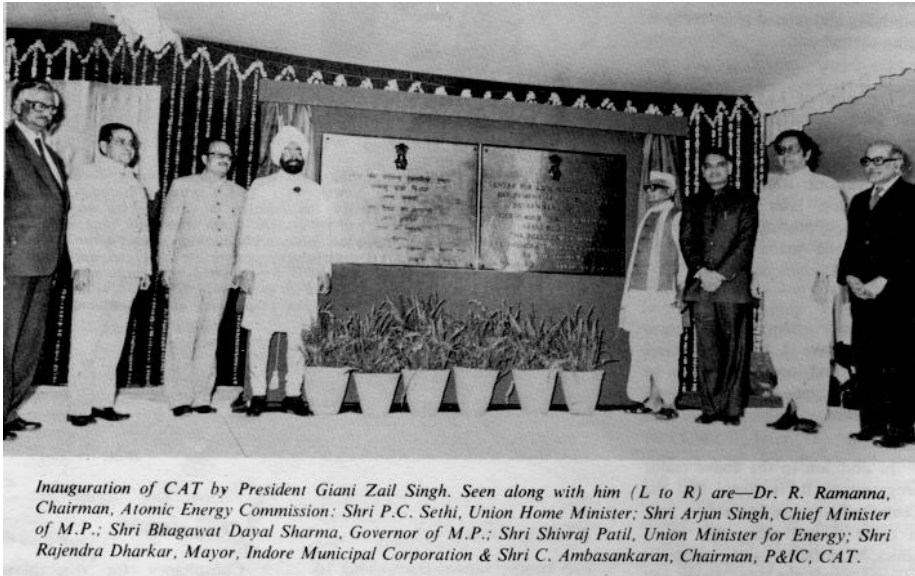

Inauguration of CAT by President Giani Zail Singh. Seen along with him (L to R) are—Dr. R. Ramanna, Chairman, Atomic Energy Commission; Shri P.C. Sethi, Union Home Minister; Shri Arjun Singh, Chief Minister of M.P.; Shri Bhagawat Dayal Sharma, Governor of M.P.; Shri Shivraj Patil, Union Minister for Energy; Shri Rajendra Dharkar, Mayor, Indore Municipal Corporation & Shri C. Ambasankaran, Chairman, P&IC, CAT.



Prime Minister Dr. Manmohan Singh visited RRCAT on 17th Dec.2005, and renamed CAT as RRCAT.

- Scientific activities commenced from 1987.
- Major activities are on Accelerators (Synchrotron Radiation Resources) Lasers, Cryogenics, Materials, Superconductivity.

Courtesy: Dr. P.D. Gupta

Indus Accelerator Complex

Indus-1 and Indus-2 synchrotron radiation sources are national facility.

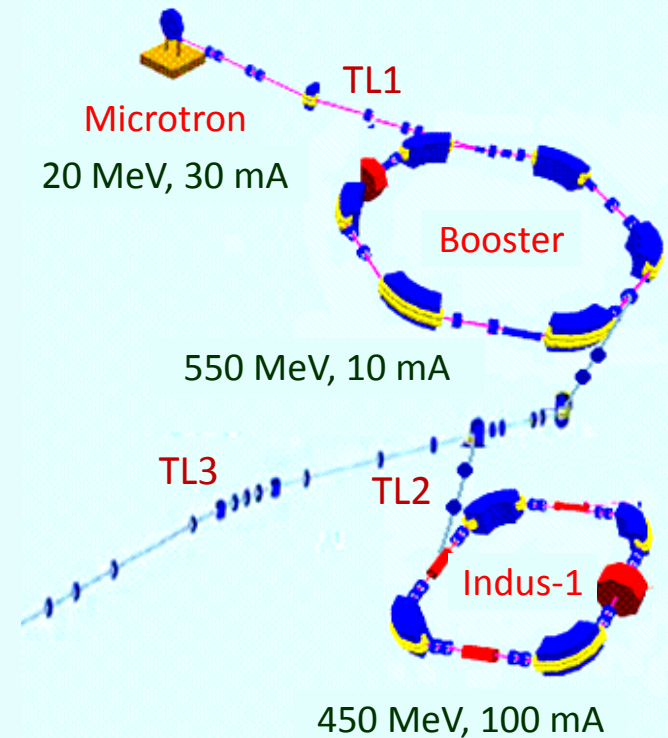
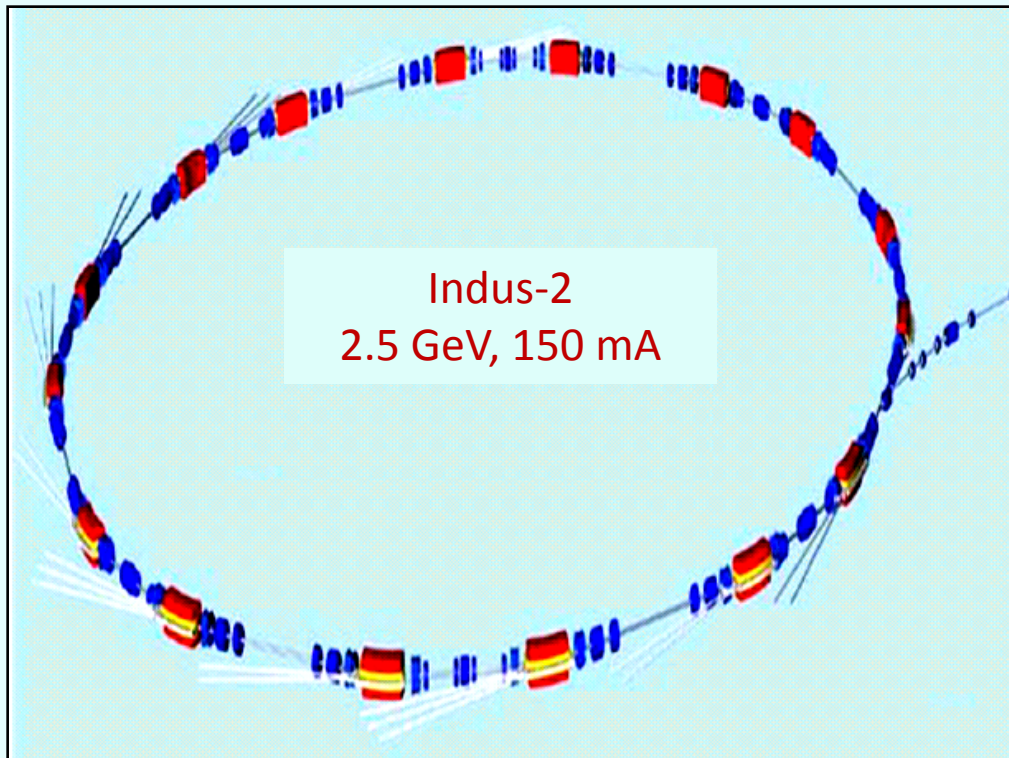

Both Indus-1 and Indus-2 are operated in three-shift mode since February 2010.

Courtesy: Dr. P.D. Gupta

Indus-2 Operation with Support of Solid State RF Amplifiers

- In-house developed high power solid state RF amplifiers (150 kW CW output power) have been deployed to replace two non-functional klystrons.
- Indus-2 current has been enhanced to 158 mA at 2.5 GeV energy.



Indus-2 RF station with solid state amplifiers (75 kW)

Courtesy: Dr. P.D. Gupta

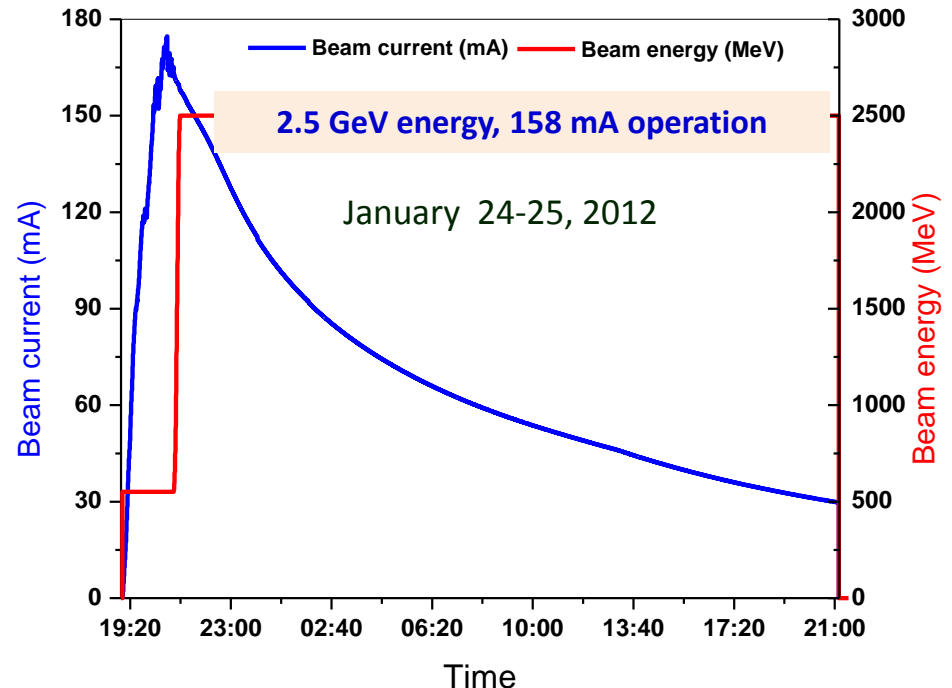

Protein crystallography Beamline at Indus-2

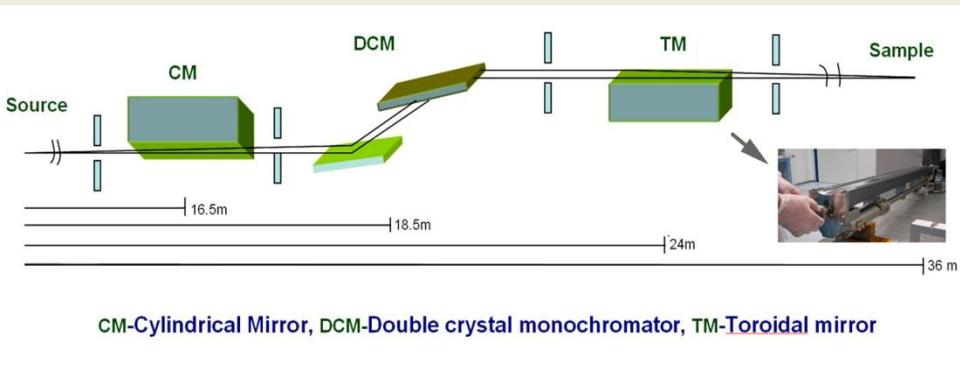

Energy Range 5-20 keV
Energy Resolution $\sim 5 \times 10^{-5}$ enabling
MAD experiments
Spot Size $0.4 \times 0.4 \text{ mm}^2$
Photon Flux $> 10^{11}$ Photons/sec at
the sample

Several high precision components such as a variety of slits, beam position viewers, hexapods for mirror alignment, mirror chambers etc were indigenously designed and fabricated



Slits, Mirror (mounted on hexapod) and DCM in optics hutch



Experimental station with CCD detector and sample cooler head etc

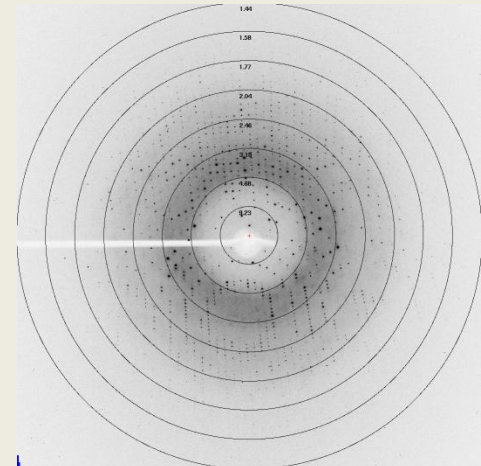

1.4 Å data recorded on Single crystal of Lysozyme
Exposure time: 30 secs

Courtesy : Dr. S.M. Sharma

X-Ray Diffraction setup at BL-11

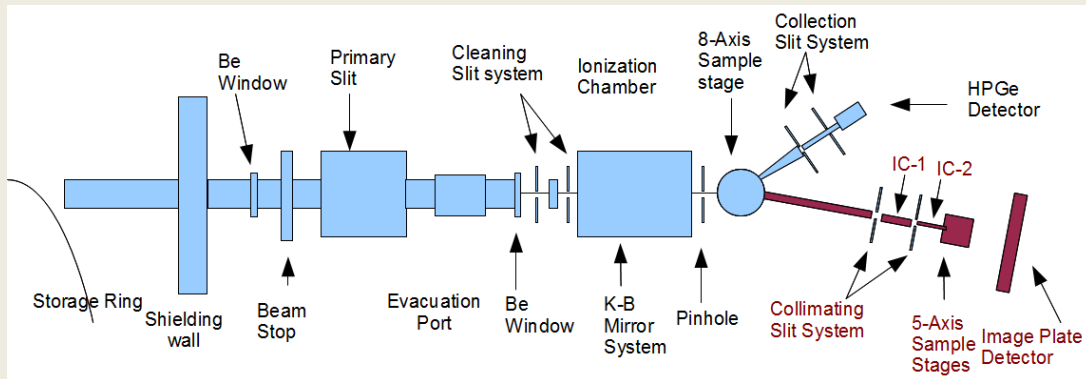

EDXRD

Energy range : 10-70 KeV
Spectral resolution : $\sim 10^{-2}$
ADXRD resolution : 10^{-4}

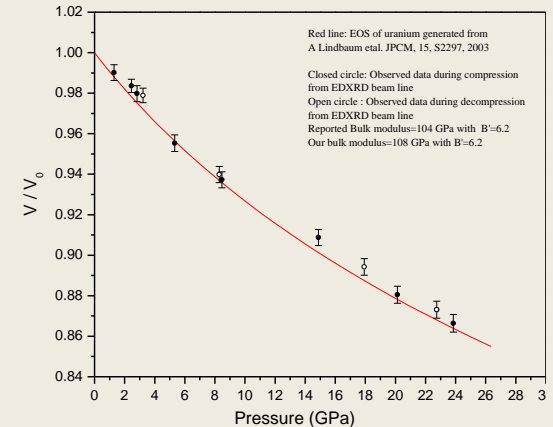
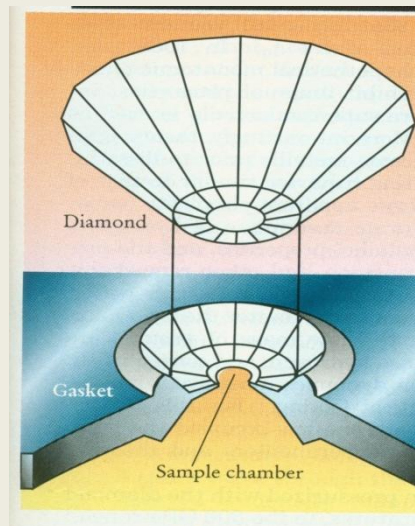
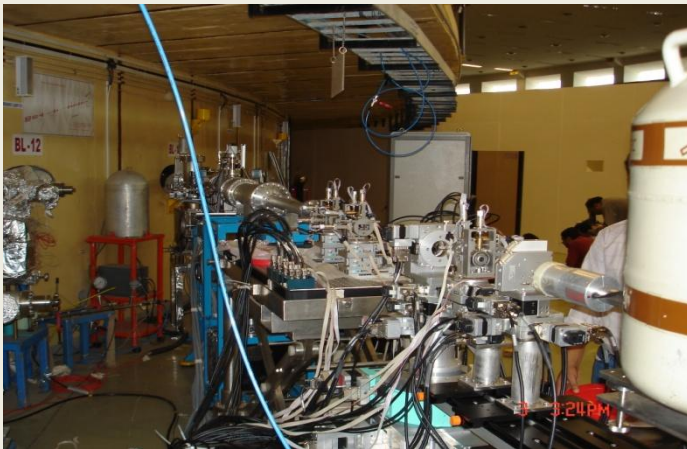

BL-11 adapted to measurements on materials under high pressures and high temperatures (upto 1200C). Several studies of importance to the department, such as EOS of Uranium (shown), its alloys etc have been carried out.

Courtesy : Dr. S.M. Sharma

Indian Beamline at Photon Factory (BL18B) KEK, Japan

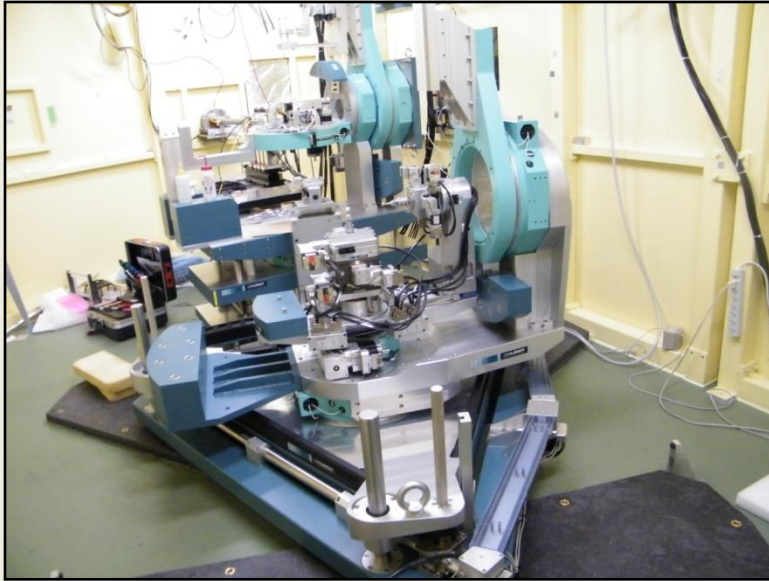

Several Indian Institutes are using this facility

- (a) Powder diffraction from (nano)materials as a function of Temperature and high-pressure – Phase transition studies . Single crystal measurements.
- (b) Reflectivity and diffuse scattering from solid and **liquid surfaces** decorated with nanoparticles and buried interfaces of nano-structured materials
- (c) Small angle x-ray scattering (SAXS) experiments within a limited range – both in transmission and reflection geometry

Courtesy: Prof. Milan Sanyal

Superconducting RF Cavity Development

- A comprehensive program for design, development, manufacturing and testing of Superconducting RF cavities and cryomodules is under implementation at RRCAT for setting up a high intensity 1 GeV proton accelerator for SNS.
- Two single-cell 1.3 GHz cavities fabricated and tested.



1.3 GHz Nb Single Cell Niobium Cavity developed in India (RRCAT / IUAC)

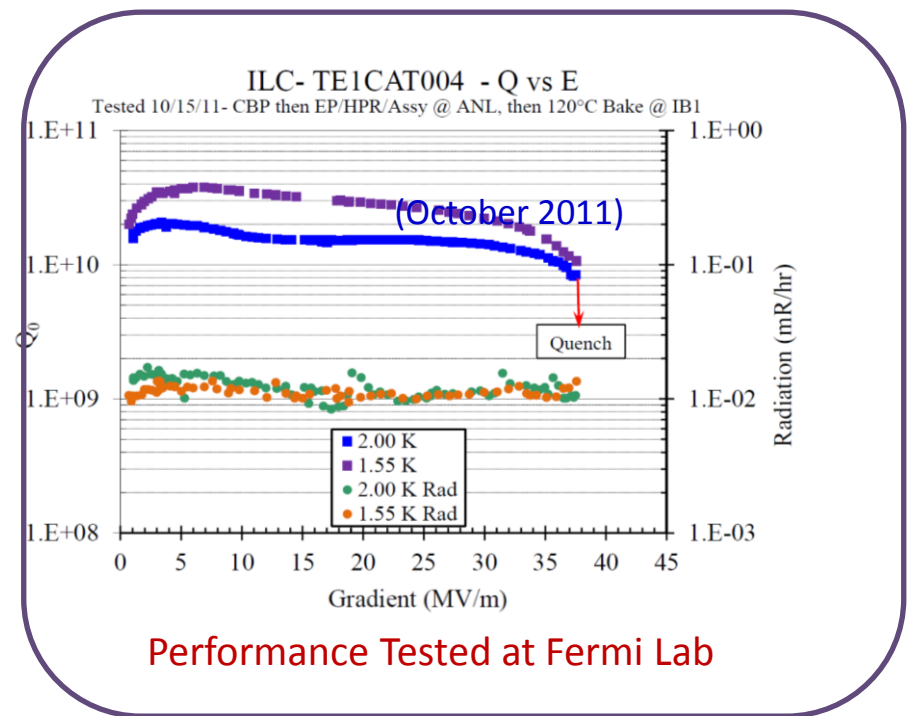

Acceleration gradient of 37.5 MV/m with Quality Factor $> 10^{10}$ at 2K

Superconducting Corrector Magnets for LHC

LHC has Dipole magnets distributed in the 27 km circular tunnel in 8 sectors. Superconducting corrector magnets are required for correcting the systematic field errors of main superconducting dipole magnets of LHC. These corrector magnets are installed with each dipole magnet in the same cryostat. The prototypes were developed and tested by Raja Ramanna Centre for Advanced Technology (RRCAT), Indore and production was done by M/s KECL under RRCAT supervision.

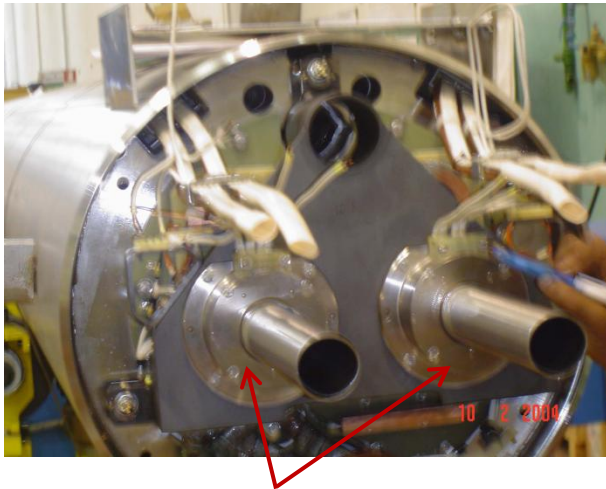

Corrector magnets in LHC dipole

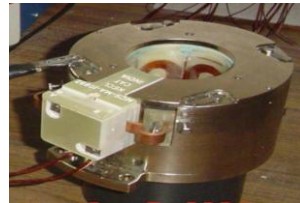
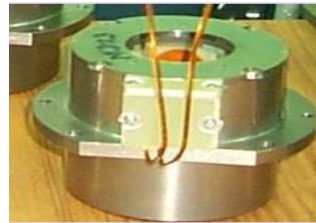

Decapole & Octupole corrector magnets



Superconducting corrector magnets supplied to CERN

Sextupole	(MCS)	1146
Decapole & Octupole	(MCDO)	616

(Courtesy: Dr. P.D. Gupta)

‘Big Science’ - Facilities

Inputs from Advanced Technologies into Equipment are needed for doing what today one calls ‘Big Science’—Accelerators and Research Reactors; Synchrotron Radiation Sources like Indus-2, Optical, Radio and Gamma Ray Telescopes; Neutrino Observatory; and so on. These are Mega-Science projects at one end of the spectrum.

From Chidambaram’s comments on IPA Theme meeting on “Synergy in Physics and Industry” held on 22.1.2013

Raman Effect and the Higgs Boson

- ❖ For discovering the Raman Effect, a physicist was enough, with a few students.
- ❖ To look for the Higgs Boson, we have the multi-billion dollar precision - engineered Large Hadron Collider and teams involving hundreds of scientists , across international borders — studying the data from various detectors. And we need an e-science infrastructure.
- ❖ So the way we do science has changed and the ecosystem must adjust to this fact

EXPERIMENTS IN 'BIG SCIENCE'

There are other technology inputs needed for experiments, e.g. beam-line instruments for SRSs. Most of these are built by scientists from DAE Laboratories, just like the neutron spectrometers and diffractometers, and the equipment needed to work in the nuclear physics and accelerator fields, we have been building over the last five decades, with progressively increasing sophistication.

From Chidambaram's comments on IPA Theme meeting on "Synergy in Physics and Industry" held on 22.1.2013

High Power Nd:Glass Laser Chain



2-arm high power Nd:glass laser
Master Oscillator - Power Amplifiers
configuration

200 J / beam, 600 ps – 2ns

Studies of laser plasma interaction in
hydro-dynamic regime

- Temperature ~ 1 million K
- Pressure ~ 100 million atmosphere

Courtesy: Dr. P.D. Gupta

Laser Driven Multi Megabar Shock Generation

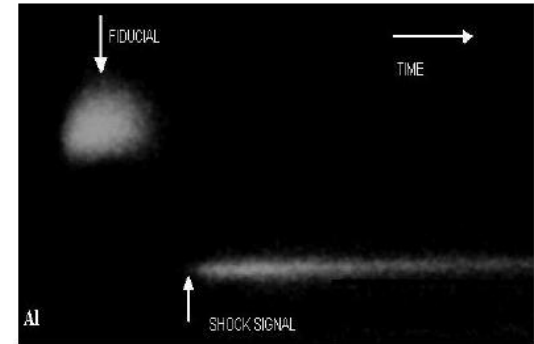
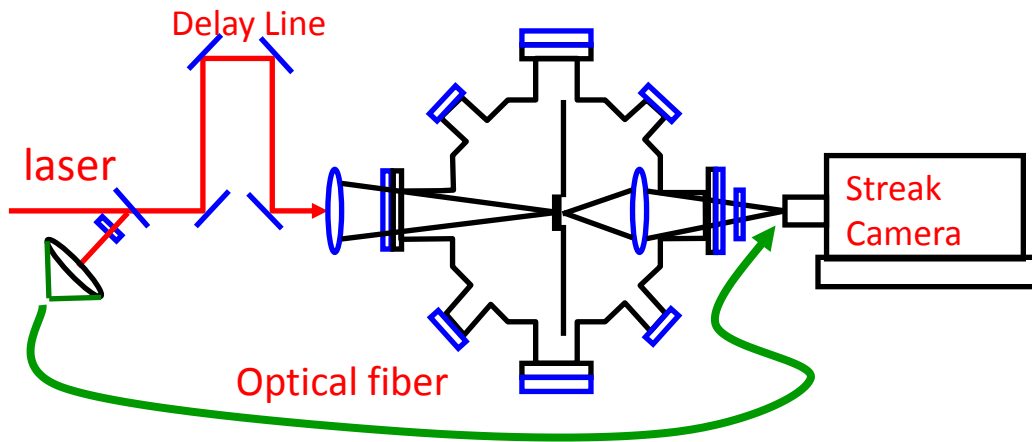

Computer Controlled Optical S-20 Streak Camera

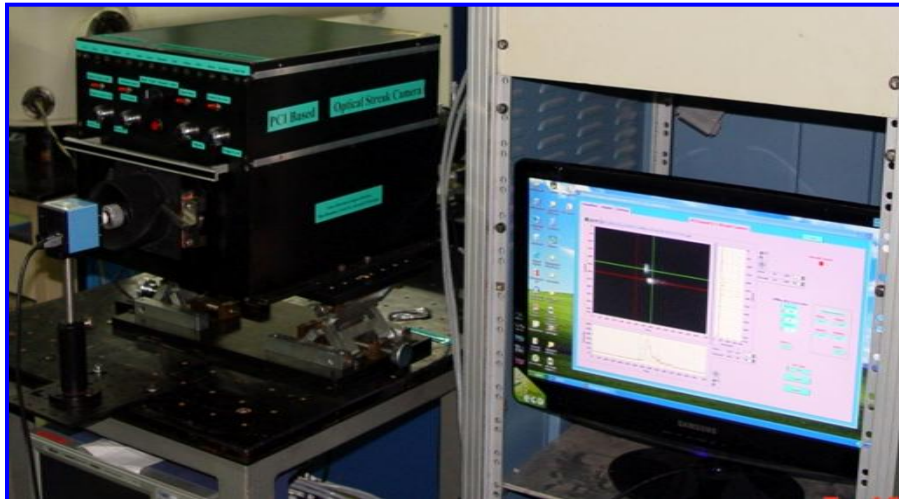

Peak intensity $\sim 10^{14}$ w/cm²

Target : Al + Au foils

Velocity = $1-2 \times 10^6$ cm / sec

Pressure = 6 - 12 Mbar

RESEARCH AND INNOVATION

Research involves generation of new knowledge and Innovation requires adding economic value (or societal benefit or strategic value or a mix of them) to knowledge, even knowledge not generated by yourself. The border between Applied Research (& also what I call 'Directed Basic Research') and Innovation, when developing cutting-edge technologies, becomes fuzzy.

Prime Minister Manmohan Singh has declared the present decade as the 'Decade of Innovation'.

LED based Portable System for Diagnosis of Oral Cancer

An LED-based, USB powered diagnostic system has been developed for field trials on patients with oral cavity cancer in Ratnagiri district, Maharashtra.



Technique based on detecting small difference in spectral characteristics of fluorescence radiation emitted by normal and cancerous cells when illuminated by a laser beam.

- The system is presently being validated at TMH, Mumbai.
- More than 200 patients studied so far.

Ophthalmic Green Laser



A laser photo-coagulator developed to treat Diabetic Retinopathy and given to Aravind Eye Hospital, Madurai

Fiber - Coupled Nitrogen Laser

for Treatment of Tuberculosis



Technology for manufacture of this system transferred to Nexus Mechatronics, Pune

Ophthalmic Green Laser

A laser photo-coagulator developed to treat Diabetic Retinopathy and given to Aravind Eye Hospital, Madurai.

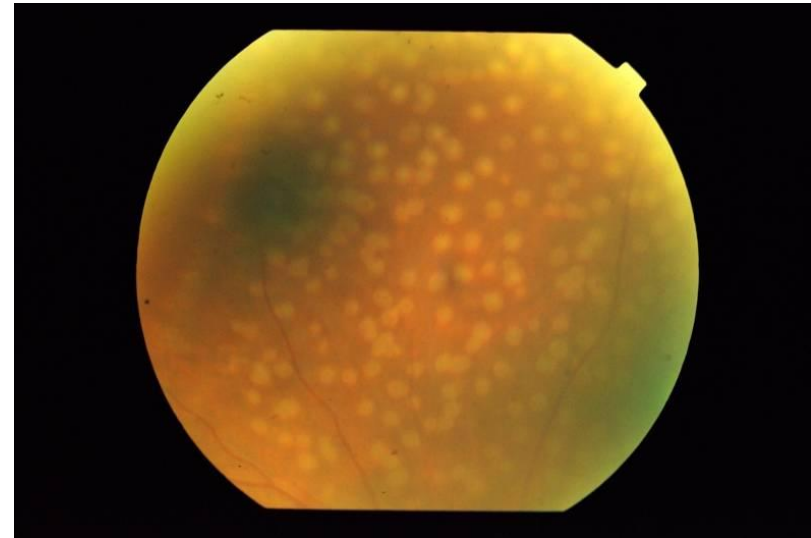

Treated retina with unit made at RRCAT.

APEX COMMITTEE FOR AN INTEGRATED PHOTONICS INITIATIVE

- **Constituted on a recommendation of the Scientific Advisory Committee to the Cabinet (SAC-C), by the PSA's Office, on the 29th of July, 2010. Chaired by Dr. A.K. Sood.**

- **The Committee has recommended the following :**
 - i. **Setting-up of a National Centre on Diode Lasers ; lead organization: the SSPL DDRD, New Delhi**
 - ii. **Creation of a Centre for studies on plasmonics for high harmonics generation, plasmonic lasers and the development of table top EUV & soft X-ray sources ; lead organization: the NPL, DSIR, New Delhi.**
 - iii. **Creation of a National Programme on Fibre Lasers ; lead organizations: the RRCAT, DAE, Indore and the CGCRI, DSIR, Kolkata.**
 - iv. **the DST shall consider funding projects and programmes in the above areas, as areas of priority, when Universities are involved.**

The PSA's Office is following-up with the said 5 Departments for the funding of the project proposals.

The Components of an Excellent R&I Ecosystem

- ❖ Talented young people (and the *Gifted*)
- ❖ Adequate Funds
- ❖ Strong Infrastructure, including e-infrastructure, (mainly the National Knowledge Network: NKN)
- ❖ Appetite for Risk-Taking
- ❖ Leaders

The Leaders

(They create their own Ecosystems)

- ❖ **Srinivasa Ramanujan** : The 'magical genius': SOLOIST
- ❖ **C.V. Raman** : Created the next generation of physicists
- ❖ **Homi Bhabha** : Created a whole field: 'Atomic Energy' - it was actually a 'leader swarm' backing Bhabha
- ❖ **J.N. Tata** : Created the concept of 'Indigenous Manufacturing Industry'.

We should not confuse *Management* with *Leadership*

Mechanisms for establishing 'Coherent Synergy' in the Ecosystem for Technology Development and Delivery

(Industrial Development vs Rural Development)

Through innovative Academia-Industry Interaction Interfaces for 'Pre-competitive Applied Research' and through 'Directed Basic Research', for Industrial Development

Examples: CAR, CMAT and CAREL of PSA's Office

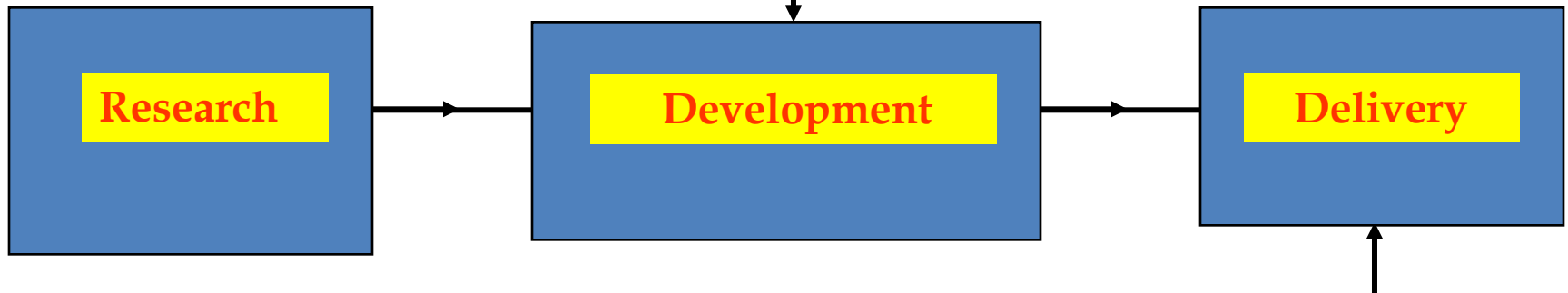

Synergy is enhanced by e-connectivity

Through Innovative Technology Delivery Systems for Rural Development. RuTAG (of PSA's Office) is an open platform innovation strategy. RuTAG Centres are there in seven IITs

'Developing' & 'Developed' Countries : A Basic Difference

Thermodynamic Equilibrium between Knowledge in the Academic System & Knowledge created in or transferred to Industry (in Developed Countries)

Lack of such Equilibrium (in Developing Countries)

That is why the R&I Ecosystems are different in India at present and, say, the U.S.A .

But Things are changing rapidly in India

“Being in the forefront in Advanced Technologies”

“After the second world war, the U.S ... led the world through the Department of Defense’s (DoD’s) central role in technology development. To support this technology base, the DoD invested in emerging fields....Resulting waves of innovation created whole industries that helped to fuel the US economy.... The attributes that accounted for the military’s successes (included), in particular, its focused mission. and its role as an early customer for advanced technologies”.

Daniel Sarewitz, Nature 471, 137(9 March 2011)

India, I think, should also be in the forefront as a first introducer of new advanced technologies. The so-called ‘Proven’ Technologies, unless followed by continuous evolutionary improvements, are often a synonym for ‘Obsolete’ technologies.

India's Foreign Exchange Reserves

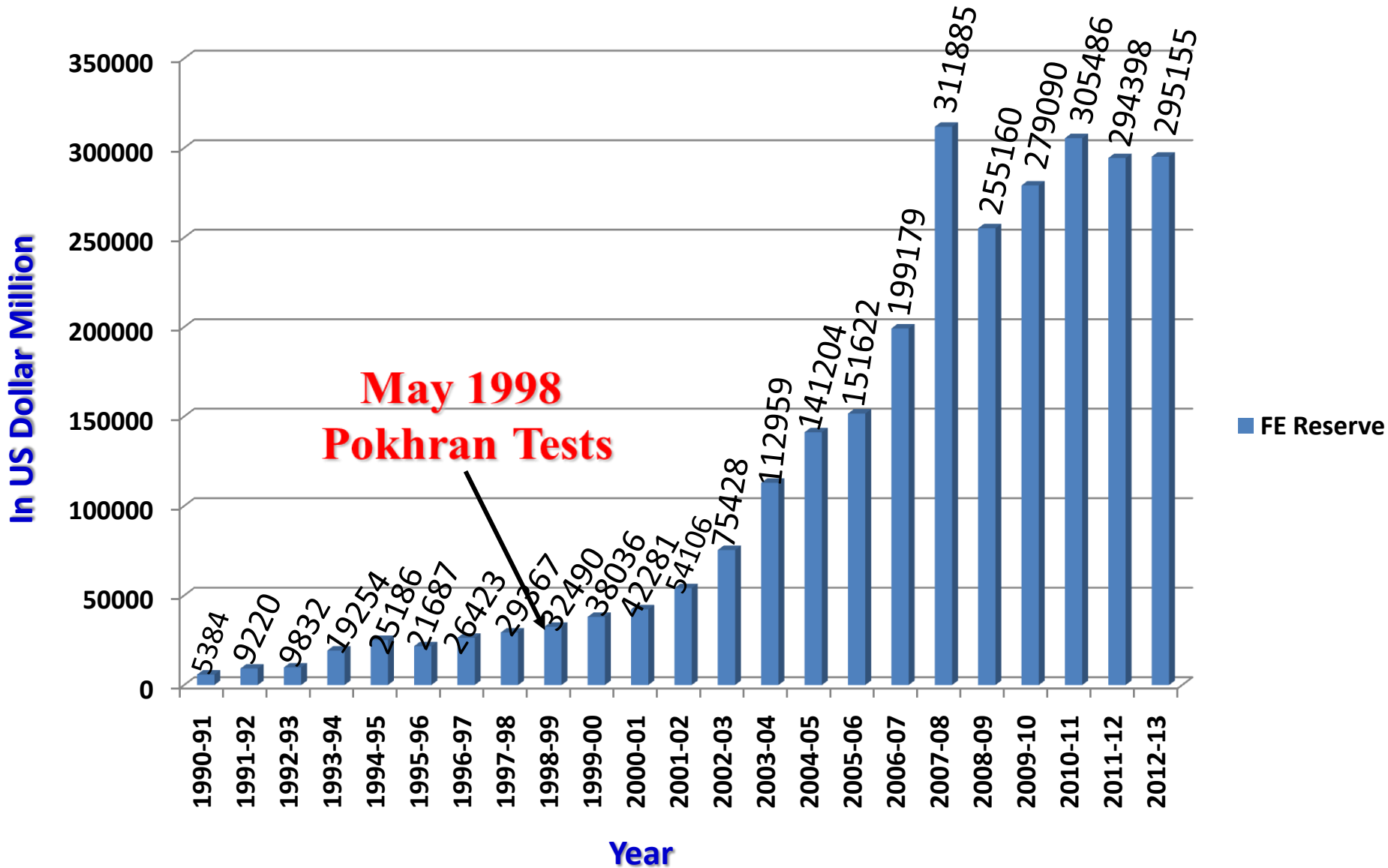

Unlike, as predicted by some economists, the May 1998 tests did not hurt the Indian economy. Appears, in fact, to have probably helped it!

Scientific Temper

We must, as a society, enhance the spread of what Jawaharlal Nehru used to describe as the *scientific temper*. Our younger generations must adopt a science-based value-system in order to benefit from what science can offer and to make up for lost time. Complex issues, be they genetically modified food or nuclear energy or exploration of outer space, cannot be settled by faith, emotion and fear but by structured debate, analysis and enlightenment. A scientific approach and understanding of these issues are therefore as vital as our core scientific capabilities.

PM's address at the Indian Science Congress, 3rd January, 2013

INDIGENIZATION OF HI-TECH EQUIPMENTS

If Industry is to manufacture hi-tech equipment like electron microscopes, x-ray diffractometers and NMR spectrometers, and other analytical and medical diagnostic and therapeutic equipment, engineers and physicists must work together. More generally speaking, in a 2004 INSA report on ‘the STRATEGIES and a Road Map for development of instrumentation in India’, a committee headed by Dr. S.K. Sikka said that “*the instrumentation industry in the West is mostly physics-based and requires interdisciplinary research between physicists, other scientists and engineers, etc..*”

From Dr. Chidambaram’s comments on IPA Theme meeting on “Synergy in Physics and Industry” held on 22.1.2013

“UNDIRECTED RESEARCH” IN CENTRALIZED LABORATORIES OF U.S. INDUSTRY

An American Institute of Physics study in 2008 (*Physics Today, July 2009, p.36*) says that one of its findings was that U.S. companies “haven’t achieved a consensus on how to find the best mix of longer-term research and short-term development. That is to say, they are trying to balance the need for a stream of innovative technologies with the ongoing need to report profits.” The study also finds that “Long gone are the reputed days of corporate funding of largely undirected research at centralized laboratories”. All these centralized laboratories were earlier(in and before 1980’s) heavily physics-based. The difficulty was that in their perception, physical sciences didn’t “contribute to the company’s short-term financial returns”. The solutions these companies found to these problems, the AIP study says, were based on decentralizing research through “contract research”, by “forming industrial associations” to fund “pre-competitive research” and by forming “collaborative R&D projects with government and universities”. All these approaches are valid for India also.

From Dr. Chidambaram’s comments on IPA Theme meeting on “Synergy in Physics and Industry” held on 22.1.2013

PHYSICS – BASED TECHNOLOGIES

Physics-based technologies—both stand-alone and as part of other hi-technologies-- tend to be at the top of the hi-technology totem-pole! And India's Industry (both public sector and private sector) venturing into such technologies will need courage, but long-term returns can be extraordinary. The counter-point is that, if they don't participate in physics-based technology generation, they may be relegated to the global backwoods, and India cannot become a Knowledge Economy.

From Dr. Chidambaram's comments on IPA Theme meeting on "Synergy in Physics and Industry" held on 22.1.2013

