



T.2: Laser Optogalvanic Spectroscopy and its Applications

R. Khare

Dye Laser Development Laboratory

Laser Systems Engineering Division

E-mail: rkhare@rrcat.gov.in

Abstract:

The laser optogalvanic spectroscopy (LOGS), which is based on optogalvanic (OG) effect, is a simple but an excellent technique to perform laser spectroscopy in gas discharges. The OG effect is an electrical response of a gas discharge by an electromagnetic radiation that is tuned to one of the optical transitions of the species present in the gaseous discharge. The OGE was discovered by using incoherent light sources but its actual development as a powerful spectroscopic tool began only after the advent of tunable dye lasers. Nowadays, techniques of LOGS are extensively used in wide range of applications, viz. isotopic analysis, wavelength calibration, laser frequency stabilization, trace element detection, study of Rydberg states of atoms and molecules, etc. Dye Laser Development Laboratory (DLDL) of Laser Systems Engineering Division (LSED), which has indigenously developed narrow-bandwidth, tunable dye lasers pumped by copper vapour laser, is also active in the area of LOGS. This theme article reports the fundamentals of the LOGS and development of its different advanced techniques. Various applications of LOGS and some results of our research work are also discussed in the theme article.

Introduction:

The optogalvanic (OG) effect was first described by Penning in 1928, when he observed a variation in the impedance of a neon discharge, which was irradiated by an emission from an adjacent neon discharge [1]. Similar observations were later reported on mercury and helium discharges by Kenty in 1950 and by Meissner and Miller in 1953 respectively. The OG effect was first observed in gas-discharge lasers when a change was noticed in the discharge current as the laser emission crossed threshold. It was noted that the OG effect was observed when the pumping radiation affected the metastable levels that were critically involved in the ion-electron production mechanism inside the discharge. Though the OG effect was discovered by using incoherent light sources, however the extensive and practical applications the OG effect had to wait for the advent of tunable dye lasers. The introduction of dye laser as a spectroscopic tool has dramatically changed the field of optical spectroscopy. Use of tunable dye laser demonstrated

the sensitivity of the OG effect as a useful spectroscopic tool by Green et al. in 1976 [2]. The laser optogalvanic spectroscopy (LOGS) is based on OG effect and it provides an important alternative to conventional absorption and fluorescence spectroscopies.

Optogalvanic mechanisms:

The OG effect occurs because the absorption of radiation causes a redistribution of populations in the atomic or molecular energy levels. Under steady-state discharge conditions, there exists a dynamic equilibrium among the various species of the discharge, which causes a well-defined impedance to the flow of current. The optical perturbation disturbs the dynamic equilibrium and changes the electron/ion densities, which in turn changes the electrical impedance of the discharge. There are numerous and complex elementary processes, which occur in a discharge. The electrons are accelerated by the electric field and their energetic distribution can be described by an elevated electronic temperature. The electron temperature at low pressures can reach values as high as 5×10^4 K and collisions with such energetic electrons cause the atoms present in the discharge to be excited or ionized. Several different ionization reactions can contribute to the discharge current. The mechanism responsible for direct ionization can be summarized as follows:

1. One-step ionization by electron impact:

An atom, A, present in a discharge can be ionized by an energetic electron (e) by the following reaction:

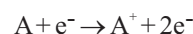

This process, known as direct ionization, dominates at low pressures because the electrons gain enough energy between two collisions.

2. Two-step or multi-step ionization:

The atom A can also be ionized by the following reactions in two- or multi-steps:

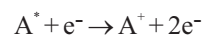
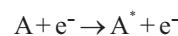

The process plays important role in inert gas discharges, where A^* is a metastable level. In these processes, the kinetic energy of the electron is converted into excitation energy.

The other important processes, in which collisions between excited atoms take place to build up excited-state population in the discharge, are described below:

3. *Excitation transfer between a ground-state atom and an excited-state atom:*

The following reaction takes place in the discharge between a ground-state atom, A and an excited-state atom, B* for excitation transfer



where, the difference of excitation energy (ΔE) is released as translation energy.

4. *Penning ionization:*

This process of Penning ionization is particularly important for discharges in inert gases, where A* is a metastable level.



In Penning ionization, the excited buffer gas atoms may ionize the sputtered atoms. The Penning ionization influences the characteristics of the discharge current. In general at higher discharge currents, the mechanism of electron impact ionization dominates over Penning ionization

5. *Associative ionization:*

In associative ionization, two atoms (or molecules), A and B, interact to form a single ion.

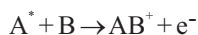

One or both of the interacting species may have excess internal energy. In the process shown above, the species A with excess internal energy (indicated by *) interacts with B to form ion AB*.

6. *Metastable-metastable collisions:*

The excited atoms (indicated by *) can produce ionization through metastable-metastable collisions as described below.



These types of collisions are mostly occur in inert gas atoms and are very effective because of high energies of the metastable levels involved.

Due to above mentioned processes, various atomic and ionic species exist in different zones of the discharge with certain population distribution in ground and excited states. When a laser beam irradiates the discharge and laser wavelength is tuned around a transition, $E_i \rightarrow E_k$, between two levels of atoms or ions in the discharge, the population

densities, $n_i(E_i)$ and/or $n_k(E_k)$ are changed by optical pumping. The change in steady state population of these two levels leads to a change of discharge current because the ionization probabilities from these two levels are different. The change in discharge current (ΔI) is detected as voltage change, $\Delta V = \Delta I.R$, across the ballast resistor (R), which is referred to as OG signal. Since the absorbed laser photons are detected by the optically induced current change, the effect is termed as *optogalvanic (OG) effect*.

The LOGS is a very sensitive technique to detect optical transitions because moderate laser powers (a few mW) give large OG signal (μV to mV) in gas discharges of several mA with a very low level of background noise. The temporal pulse shape of an OG signal at a wavelength of 588.2 nm, corresponding to transition $1s_5 \rightarrow 2p_2$ (Paschen notation) of neon, observed in a zirconium-neon hollow cathode discharge lamp at 10 mA discharge current at our laboratory is shown in Fig.T.2.1.

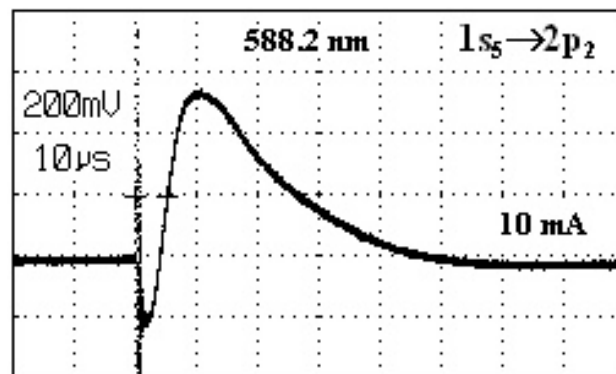

Fig. T.2.1: Pulse shape of an OG signal, observed at 588.2 nm in zirconium-neon hollow cathode discharge lamp at 10 mA discharge current.

Radiation from all kinds of lasers, single-frequency as well as tunable, single-mode or multi-mode, continuous-wave (cw) or pulsed have been used to perform LOGS in different kinds of discharges, viz. hollow cathode discharge, positive column discharge, radiofrequency (rf) discharge, microwave discharge, direct current discharge, flame, indicator lamp, etc.. Some discharge sources are described below.

1. *Hollow cathode discharge lamp:*

The hollow cathode discharge lamps (HCDLs) have been widely used as an atomic vapor or emission source for most elements in the periodic table. A “see-through” HCDL, which is extensively used in LOGS, consists of a hollow

cylindrical metal cathode and a ring anode, both mounted in a glass enclosure, which is filled with a buffer gas. Schematics of a “see-through” HCDL is shown in Fig. T.2.2.

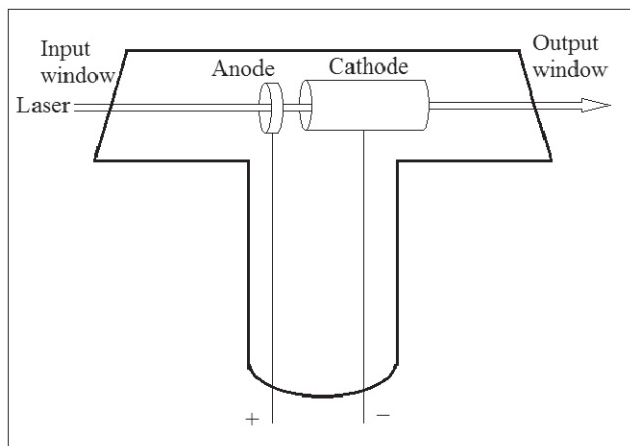

Fig. T.2.2: Schematics of a “see-through” hollow cathode discharge lamp (HCDL).

When DC voltage is applied to the electrodes of HCDL, an intense discharge concentrates inside the hollow of the cathode. The discharge consists of a bright glow, filling the interior of the cathode, and an annular dark space close to the inner wall of the cathode. The bright glow is the negative glow region, where the main mechanisms leading to the OG effect occur. The highly refractory elements, which are difficult to vaporize by thermal means, are produced in gas phase by cathode sputtering in hollow cathode discharges. Another advantage of HCDL is that the spectral lines of its spectra are very narrow. The HCDLs are widely used to study OGE because of their low galvanic noise and enlarged negative glow region. Using an indigenously developed tunable dye laser pumped by copper vapour laser, we have recorded OG signals, corresponding to transition $4f^7 6s^2 \ ^8S_{7/2} \rightarrow 4f^7 6s 6p \ ^6P_{7/2}$ of europium at 576.520 nm and four close-by strong OG signals of neon at 576.05885, 576.40525, 576.44188 and 577.03067 in an europium-neon “see-through” hollow cathode discharge lamp [3].

2. Positive column discharge:

Positive column, the luminous region of glow discharge, is characterized by spatial uniform brightness, whose color depends on the particular gas or vapor. The axial component of the electric field in the positive column is constant and the concentrations of the positive ions and electrons are equal throughout. The line profiles of OG signals, generated in neon positive column discharge, at 588.2 nm corresponding to

transition $1s_5 \rightarrow 2p_2$ (Paschen notation), showed change in sign as a function of dye laser power for a pressure of 1.5 Torr and currents in the range of 2-20 mA [4].

3. Radio-frequency discharge:

A low-pressure glow discharge can be obtained by using a radio-frequency (rf) field. The plasma is coupled to the rf oscillator by placing the sample inside the oscillator circuit, in a coil (inductive coupling) or in a capacitor (capacitive coupling). One advantage of rf discharges is that it can be operated with high stability in a range of pressures that are generally much larger than that in case of dc discharges. In comparison to dc discharge, the rf discharge is an electrodeless discharge and thus it eliminates sputtering and contamination even in the presence of reactive or corrosive species. A new Rydberg band of the N_2 molecule has been observed around 590 nm while studying LOGS with radio-frequency discharges of Ar, N_2 , NH_3 and NO_2 in the wavelength region between 580 and 630 nm [5].

4. Flame:

A flame can be considered as a source of very weak plasma. LOGS in flames has been proved to be a sensitive method for detection of trace elements and radicals in the flames. Unlike flow discharge, the atmospheric pressure flame exhibits local thermodynamic equilibrium because of which laser excitation of species in flames leads to increased ionization and this technique is sometimes called laser-enhanced ionization (LEI) spectrometry. A flame is a chemically-sustained plasma in contrast to the electrically-sustained flow discharge, hence a pair of suitable metal rods or plates are placed across the flame and both rods, which are joined together serve as an electrode and are connected to a stable DC power supply whereas the body of the burner is grounded and it serves as the other electrode. The change in the conductivity of the flame due to absorption of photons is detected as OG signal. Shortly after introduction of LOGS, it was applied to detect different concentrations of sodium in an air- C_2H_2 flame [6].

5. Indicator lamp:

The indicator lamps are miniature glow lamps, which are used as indicator lamps and circuit elements. Such lamps are constructed by mounting two parallel rod electrodes in a glass enclosure filled with some rare gas at reduced pressures. Indicator lamps are used to obtain OG signals for frequency locking and wavelength calibration of lasers. The use of an indicator lamp as an OG wavelength sensor is attractive due to its simplicity, readily availability, compactness, low power consumption and low cost. The indicator lamps are very

rugged and not affected by vibration, mechanical shock, or frequent on/off operation. The OG spectra of neon and argon in such an indicator lamp have been studied for wavelength calibration of laser [7].

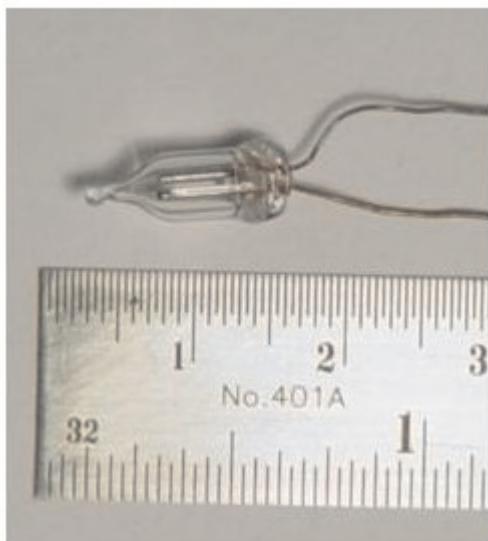

Fig. T.2.3: Photograph of a miniature neon indicator lamp.

We have studied the pulsed OGE in a miniature neon indicator lamp, which is shown in Fig. T.2.2(b), and recorded the OG spectrum of neon for using it as a calibration device in an indigenously developed tunable dye laser pumped by copper vapour laser [8]. We have also observed the anomalous OG effect, for the first time, in a miniature neon indicator lamp [9].

Experimental method:

The OG signals can be measured either as a change in voltage across the discharge or a change in current in the ballast resistance, and the choice is arbitrary. The current in the gas discharge is monitored. As the frequency or wavelength of the tunable laser is varied, changes in the discharge current is detected. Both positive as well as negative OG signals are observed during detection. The OG spectrum is obtained by recording the current as a function of the wavelength of the laser. The OG spectrum is remarkably similar to an emission or absorption spectrum. Both continuous-wave (cw) as well as pulsed tunable lasers are used in LOGS to observe OG signals. A typical experimental set-up, used to carry out LOGS with a pulsed tunable dye laser, is shown in Fig. T.2.4. In the set-up, a see-through hollow cathode discharge lamp (HCDL), filled with an inert gas, is used to produce the atomic vapors of cathodic element.

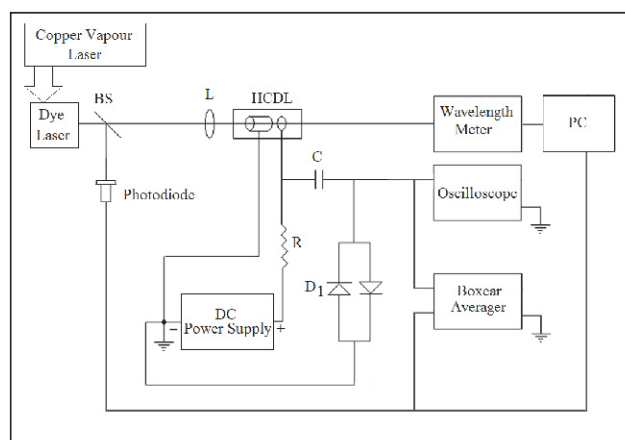

Fig. T.2.4: A typical experimental set-up for performing LOGS with a pulsed dye laser.

The HCDL is excited by a regulated high-voltage DC power supply. A circuit mainly consisting of high-value ballast resistance (R) and a coupling capacitor (C) is used to detect the OG signals. The ballast resistance limits the discharge current in the HCDL. The dye laser beam is focused by a lens (L) for axial irradiation of the hollow cathode discharge. Whenever the laser beam was resonantly absorbed by the discharge medium, the voltage across the discharge tube varied and these variations were coupled by a capacitor (C) to an oscilloscope to record the temporal pulse shape of the OG signal. The oscilloscope was protected from high voltage transients by a pair of fast diodes (D_1 and D_2) mounted in parallel. The OG signals are also acquired on a computer through a boxcar averager for which the output signal from a fast photodiode is used to generate the gate window to obtain integrated time-averaged noise-free OG signals. A part of the dye laser beam or unused dye laser beam is sent to a monochromator or a wavelength meter coupled to a personal computer (PC) to accurately measure the wavelength of the dye laser beam, which is being tuned.

Advantages of laser optogalvanic spectroscopy:

The laser optogalvanic spectroscopy (LOGS) provides an important alternative to the conventional absorption and fluorescence spectroscopic techniques. The absorption spectroscopy is limited to samples that have sufficient optical density to absorb a detectable amount of incoming radiation. The fluorescence spectroscopy becomes unsuitable if the sample fluoresces at a wavelength, which is not suitable for optical detectors (such as VUV). The LOGS does not suffer from these limitations because it does not require photo-detector or optical system of high geometric photon collection efficiency. Thus the LOGS offers a simple but a powerful

technique to detect weak absorptions in gaseous discharge. Furthermore the spectrum of high lying states can be obtained by using LOGS because these states can be reached by exciting radiative transitions starting from metastable levels, which are well populated in the discharge.

The limit on the sensitivity of the OG signal is set by the electrical noise in the discharge. Thus to achieve higher sensitivities, it is necessary to make the discharge electrically quiet. In fact, a properly designed discharge tube can be operated at the shot noise limit or even below it.

Advanced techniques of LOGS:

Several advanced techniques of LOGS have been developed and some of these are discussed. The combination of Doppler-free spectroscopic techniques and optogalvanic detection has produced sensitive new methods of high resolution spectroscopy.

Doppler-free OG signals are generated on single photon detection by using intermodulation. The *Doppler-free intermodulated optogalvanic spectroscopy (IMOGS)* has similar detection scheme as that of Doppler-limited OG spectroscopy. In Doppler-free intermodulated OG spectroscopy, the laser beam is split into two parts of almost equal intensity. The two beams, which are chopped at two different frequencies, f_1 and f_2 , are sent to the discharge along opposite directions. Thus the two beams, in general, interact with different velocity groups of atoms under the Doppler profile of a given transition. However when the laser is tuned to the centre of the transition, both beams interact with the same group of atoms, namely those that have no velocity along the beams and thus have no Doppler shift. In this particular case, Doppler-free OG signals, modulated at $(f_1 + f_2)$ and $(f_1 - f_2)$ are obtained along with Doppler-broadened signals at f_1 and f_2 . The sum frequency is conveniently detected with a lock-in amplifier. While comparing the sensitivities of IMOGS and Doppler-free saturated absorption spectroscopy, it is reported that signal to noise ratio in IMOGS is 100 times better than that in Doppler-free saturated absorption spectroscopy [10]. The technique of IMOGS was used in studying highly excited states in He and Ne atoms in hollow cathode discharge and lines as narrow as 60 MHz were observed for $3s_5 \rightarrow 5p_{10}$ transition of Ne [11]. This technique was also used to measure the isotope shifts of some dipole transitions between excited states of $^{88,86}\text{Sr}$ I and II [12].

The technique of *Doppler-free two-photon optogalvanic spectroscopy (TOGS)* is also developed to eliminate the

Doppler broadening. The TOGS is based on entirely different principle from saturation spectroscopy for the elimination of Doppler broadening. In this technique, the laser is tuned in such a way that its wavelength corresponds to half of the energy difference between two energy levels and the atoms make a transition by absorbing two photons from opposite beams. The advantage of this technique are: (a) first order Doppler shift is cancelled exactly and (b) all atoms in the interaction zone contribute to the OG signal, irrespective of their velocities. The first use of this technique was in the observation of thirteen two photon transitions of neon [13]. TOGS was applied to observe Doppler-free two-photon transitions, $2^3\text{S} \rightarrow 5^3\text{S}$ and $2^3\text{S} \rightarrow 5^3\text{D}$, of ^4He [14].

The technique of *Polarization intermodulated excitation spectroscopy (POLINEX)* was developed as a sensitive OG technique for Doppler-free spectroscopy. In this technique, the polarization of one or both counter-propagating beams of the tunable laser are modulated rather than the intensity of the beam as in IMOGS. The POLINEX was used to resolve the hyperfine structure in the $2^3\text{P} \rightarrow 3^3\text{D}$ transition in ^3He [15].

In *multistep, multiphoton laser optogalvanic spectroscopy*, the technique of laser optogalvanic spectroscopy is applied for multistep and multiphoton excitation of atomic and molecular levels to study high lying bound as well as autoionization states. Knowledge of autoionization states is important to get insight into basic atomic physics and also identify efficient ionization pathways for ultra-trace elemental analysis and isotopic selective photoionization of atoms using resonance ionization spectroscopy (RIMS). The three-photon, three-step laser optogalvanic spectroscopy was applied to identify 102 new even-parity autoionization resonances of atomic uranium in a uranium-neon hollow cathode discharge by using four different excitation schemes with three pulsed dye lasers [16].

Anomalous Optogalvanic Signal:

In normal OGE, the waveforms of the OG signals are time-independent stationary pulses, however in certain experimental conditions, the OG signals become time-dependent damped oscillations. Such sustained auto-oscillations are termed as “anomalous optogalvanic signal”. Anomalous OG signals are reported in argon discharge-cell [17] and arsenic-neon hollow cathode discharge lamp [18]. The origin of anomalous OGE is attributed to operation of discharges in regions, where dynamic resistance becomes negative. The dynamic resistance of the discharge becomes negative due to Penning ionization via quasi-resonant energy transfer collisions between inert gas atoms in the metastable state and sputtered electrode atoms in ground state. We have

studied laser induced OG effect in a neon indicator lamp in positive as well as negative dynamic resistance regions and observed, for the first time, the anomalous OGE in the discharge of a neon indicator lamp [9]. When the neon indicator lamp was irradiated by a Rhodamine 6G dye laser pumped by copper vapor laser, the anomalous optogalvanic signals were observed at the wavelengths 588.2, 594.5, and 597.6 nm corresponding to transitions, $3s[3/2]_2 \rightarrow 3p'[1/2]_1$, $3s[3/2]_2 \rightarrow 3p'[3/2]_2$, and $3s[3/2]_2 \rightarrow 3p'[3/2]_1$ of neon. Various waveforms, recorded in a complete cycle of the anomalous optogalvanic signals, observed at 588.2 nm, are shown in Fig. T.2.5(A-I). These result suggest that neon gas atoms form a good Penning mixture with elements (Ni, Cu, Fe, etc.) of electrodes material.

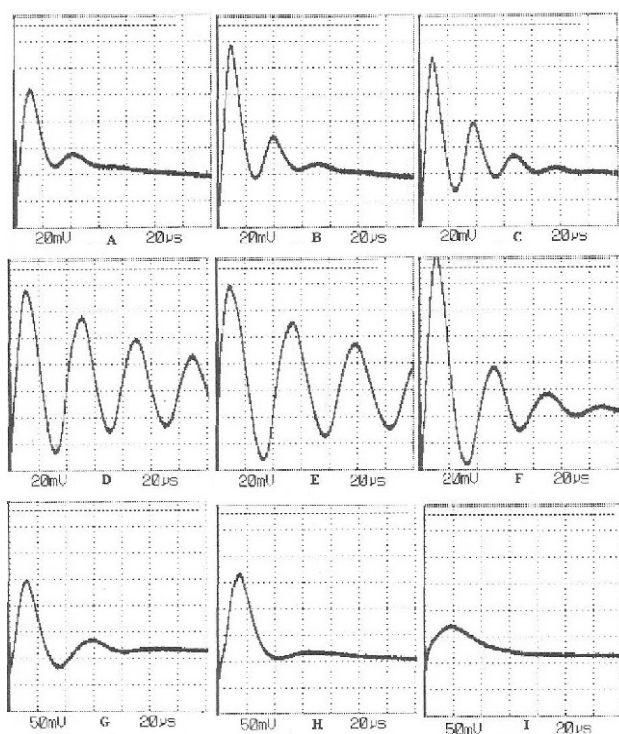

Fig. T.2.5: Various waveforms, recorded in a complete cycle of the anomalous optogalvanic signals, observed at 588.2 nm in a neon indicator lamp.

The experimental results of the anomalous optogalvanic effect in the neon indicator lamp are also simulated by using a discharge equivalent-circuit model [19]. The discharge plasma is more sensitive and less stable in the close vicinity to dynamic resistance sign inversion, so it can be very useful in detection of OG signals of weak optical transitions.

Applications of LOGS:

1. Wavelength calibration:

The LOGS provides an accurate and economical technique to calibrate the wavelength of tunable lasers. A small fraction of the output from a tunable laser is taken out to irradiate a suitable discharge lamp and OG spectrum of the discharge is recorded simultaneously with the unknown spectrum under investigation. OG spectra of various elements, viz. argon, neon, uranium, thorium, etc., have a number of strong spectral lines, which are well spread over the visible and near-IR regions. These spectral lines, which are tabulated unambiguously along with their relative emission-intensities, serve as convenient absolute wavelength markers. A fully automatic wavelength calibrator using OGE in an iron-argon/neon mixture hollow cathode discharge was developed to calibrate a tunable dye laser and its second harmonic over a spectral range of 220 to 740 nm [20]. An iron-neon hollow cathode discharge lamp was also used to calibrate a tunable dye laser by observing 351 OG transitions in 337-598 nm region [21]. The OG spectrum, obtained from suitable hollow cathode discharge lamp, is used for absolute calibration of wavelength of tunable dye lasers to identify new energy levels of several atomic species [22, 23].

2. Laser frequency-stabilization:

The LOGS is used in various ways to provide active frequency-stabilization to all kinds of lasers. The OG signal, derived from a gas discharge, is used frequency lock pulsed as well as continuous-wave (cw) tunable lasers to both resonance and excited state transitions in a wide variety of elements. In this technique, no optical detector is required because the electrical signal for the feedback loop is derived from a change in the voltage across the discharge as the laser is tuned to an optical transition of a species present in the discharge. The elimination of optical detectors is very important because the scattered excitation light no longer limits the usefulness of the locking scheme and consequently large oscillator strengths or large luminescence yields are not necessary. The LOGS was used to lock a cw dye laser to several resonances and excited state transitions in Na-Ne and Ba-Ne hollow cathode lamps [24]. The OGE in the external cavity OG cell was investigated as a function of CO₂ gas pressure, discharge current and chopping frequency for frequency stabilization of a cw CO₂ laser [25, 26].

3. Trace element detection:

The LOGS provides an ultrasensitive detection

technique for trace element detection. LOGS is best suited for trace element detection in flames down to 0.01 ppb level. Concentrations as small as pictogram (pg) per mL are routinely detected in alkali elements and the amplitude of observed signals are linear with concentration of the specie. In usual LOGS in a flame, the OG signal is obtained by thermal ionization of selectively excited species. The LOGS is also performed to detect the presence of atoms and radicals directly involved in the combustion mechanism. The OG signal in an air-C₂H₂ flame was enhanced by a factor of 100 to attain a detection limit of 5 ppt (pg/mL) for Ca atoms when an intense UV laser beam was applied to the flame for selective multi-step photo-ionization [27].

4. Study of Rydberg states of atoms and molecules:

The LOGS is extensively applied to the study of Rydberg states. The Rydberg states of atoms and molecules can be reached by exciting radiative transitions starting from metastable levels, which are well populated in a discharge; that is why the LOGS has been very successful in studying the Rydberg states. The transitions from 2s¹S metastable to high np¹P (n = 14-36) states of atomic helium is studied using OG effect in He discharge [28]. The observed transition frequencies agreed well with the predictions of quantum defect theory. This study indicated that Rydberg states are not strongly perturbed internally or by their environment and thus can be investigated using OG technique. Using a pulsed dye laser, Rydberg levels of Kr are observed with an accuracy of 0.03 cm⁻¹ by the LOGS [29].

5. Study of Penning ionization:

A novel application of the LOGS was demonstrated when it was established that the Penning ionization of sputtered atoms by metastable atoms of buffer gas in hollow cathode discharges influenced the temporal evolution of the OG signals corresponding to resonant excitation of the metastable atoms of the buffer gas. It was observed in discharge of Ca-Ne hollow cathode that the temporal evolution of the OG signal of buffer gas transitions showed a double hump as a signature of Penning ionization [30]. The double humped feature in the temporal profile of the OG signal, corresponding to a transition of the buffer gas is reported in discharges of hollow cathodes of Sr-Ne [31], Hg-Ne [32], and Cs-Ne [33].

We have studied the temporal evolution of the OG signal of Ne as a function of discharge current in a Zr-Ne hollow-cathode discharge, irradiated by indigenously developed tunable Rhodamine 6G dye laser, pumped by copper vapor laser [34]. The temporal evolutions of the OG signal in the

Zr-Ne hollow-cathode at wavelengths 588.2, 594.5, 597.6, and 614.3 nm corresponding to transitions, 3s[3/2]₂ → 3p'[1/2]₁, 3s[3/2]₂ → 3p'[3/2]₂, 3s[3/2]₂ → 3p'[3/2]₁, and 3s[3/2]₂ → 3p'[3/2]₂ of neon, is studied as a function of discharge currents. The temporal evolution of the OG signal of neon as a function of discharge current in the mixture of Zr-Ne hollow cathode at 594.5, 597.6, and 614.3 nm are shown in Fig. T.2.6. The temporal profiles of OG signals are similar in nature but not exact replica.

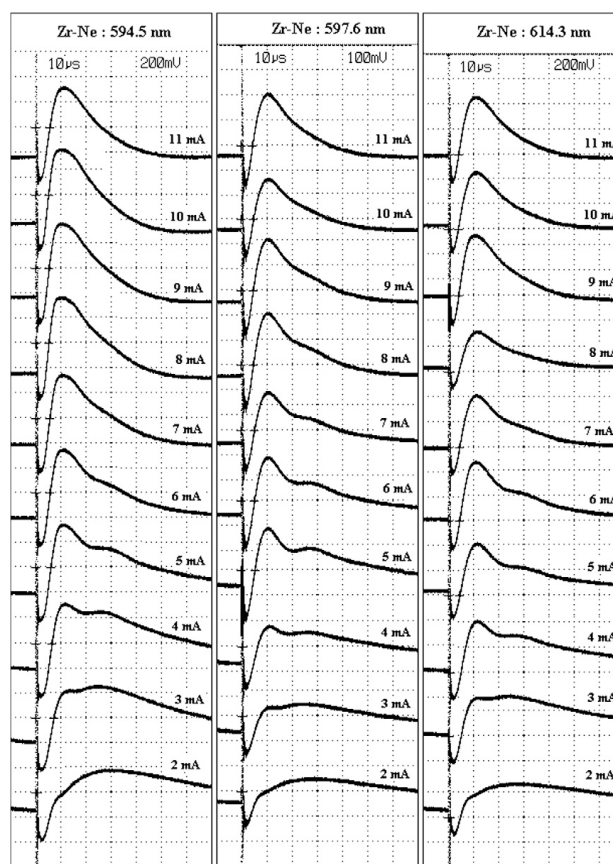
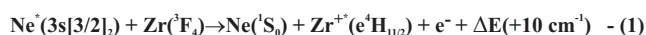

Fig. T.2.6: Temporal evolution of OG signals of neon at 594.5, 597.6, and 614.3 nm for discharge currents in the range of 2–11 mA.

The feature of double hump in the temporal profile of the OG signals is observed at low discharge currents (5 mA) in the Zr-Ne discharge while at currents (10 mA), the double hump disappeared. The important processes that ionize sputtered Zr atoms in a Zr-Ne hollow cathode discharge are Penning ionization and electron impact ionization. Thus the Penning ionization takes place at lower discharge currents while at higher discharge currents, the electron impact

ionization is dominant over the Penning ionization in the Zr–Ne discharge.

In the Zr–Ne discharge, the excited metastable Ne atoms at $3s[3/2]_2$ level collide with neutral Zr atoms, existing in the 3F_3 and 3F_4 levels, and excite them to $^4H_{7/2}$ and $^4H_{11/2}$ levels of Zr^+ by Penning ionization. Collisional energy transfer takes place between excited Ne($3s[3/2]_2$) atoms and $Zr(^3F_3$ and $^3F_4)$ atoms by the following Penning ionization processes:



where * indicates an excited state. The energy defect, $\Delta E = (+10, -41 \text{ cm}^{-1})$, is within thermal energy kT and is attributed to the translational energy of the collision partners. The relevant energy levels of Ne and Zr, which are required to explain the Penning ionization process in the Zr–Ne mixture discharge are shown in Fig. T.2.7.

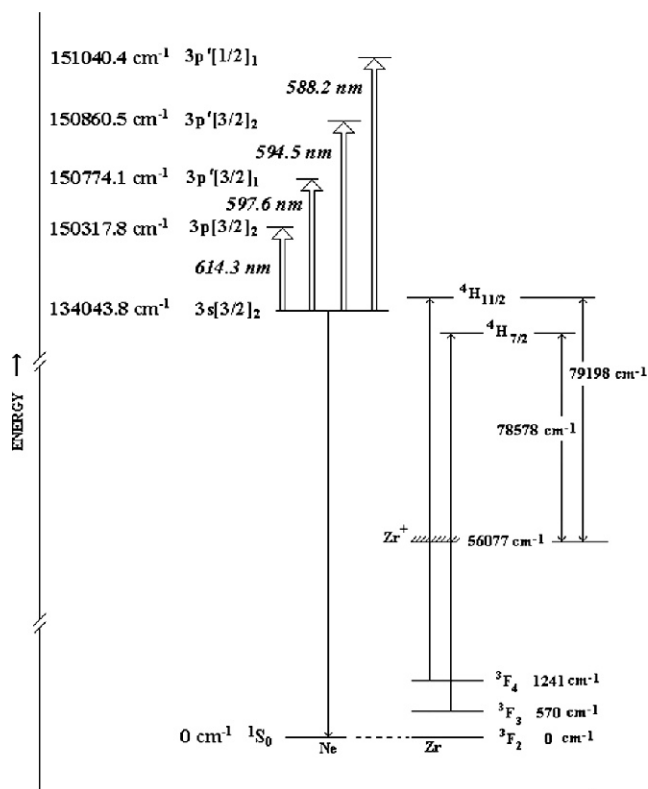

Fig. T.2.7: Partial energy level diagram for the relevant Zr, Zr^+ and Ne atomic levels related to Penning ionization of Zr by neon atoms at $3s[3/2]_2$ level.

Conclusions:

The optogalvanic effect and its mechanism in gas discharge is briefly described to explain the basics of laser optogalvanic spectroscopy (LOGS). Some different kinds of discharges, viz. hollow cathode discharge, positive column discharge, radio frequency (rf) discharge, flame, and indicator lamp, which are used in LOGS are discussed. The experimental method and advantages of LOGS are described to show the simplicity and elegance of LOGS. Some advanced techniques, namely Doppler-free intermodulated optogalvanic spectroscopy, Doppler-free two-photon optogalvanic spectroscopy, Polarization intermodulated excitation spectroscopy, and Multi-step, multi-photon laser optogalvanic spectroscopy are explained in short. The anomalous optogalvanic effect, where time-dependent damped OG signals are observed, is also discussed. Finally various important applications of LOGS, like wavelength calibration, laser frequency-stabilization, trace element detection, study of Rydberg states of atoms and molecules, and study of Penning ionization are discussed in the article.

Acknowledgements:

The author is thankful to Dr. P. D. Gupta, Director, RRCAT and Shri S. V. Nakhe, Head, LSED for their support and encouragement.

References:

- [1] F.M. Penning, Physica, 8 (1928) 137.
- [2] R.B. Green, R.A. Keller, G.G. Luther P.K. Schenck, and J.C. Travis, Appl. Phys. Lett., 29 (1976) 727.
- [3] R. Khare, V.K. Saini, J. Kumar, V.K. Shrivastava, V.K. Dubey, P. Saxena, S.K. Dixit, A. Lala, J.K. Mittal, Topical Conference on interaction of E.M. Radiation with Atoms, Molecules and Clusters (TC-2010), RRCAT, Indore, (Mar. 2010) 59.
- [4] D.M. Kane, Opt. Commun., 47 (1983) 317.
- [5] T. Suzuki, Opt. Commun., 38 (1981) 364.
- [6] R.B. Green, R.A. Keller, P.K. Schenck, J.C. Travis, and G.G. Luther, J. Am. Chem. Soc., 98, (1976) 8517.
- [7] J. R. Nestor, Appl. Opt. 21 (1982) 4154.
- [8] R. Khare, V. K. Saini, V. K. Shrivastava, S. V. Nakhe and U. Nundy, Proc. Fourth DAE-BRNS National Laser Symposium, B.A.R.C. Mumbai, p. 366, Jan. 2005.



- [9] V.K. Saini, V.K. Shrivastava, and R. Khare, *Opt. Commun.*, 281, (2008)129.
- [10] J.E. Lawler, A.I. Ferguson, J.E.M. Goldsmith, D.J. Jackson, and A.L. Schawlow, *Phys. Rev. Lett.*, 42 (1979) 1046.
- [11] D.J. Jackson, H. Gerhardt, and T.W. Hänsch, *Opt. Commun.*, 37 (1981)23.
- [12] C.J. Lorenzen, and K. Niemax, *Opt. Commun.*, 43 (1982) 26.
- [13] J.E.M. Goldsmith, A.I. Ferguson, J.E. Lawler, and A.L. Schawlow, *Opt. Lett.*, 4 (1979) 230.
- [14] J.E.M. Goldsmith, and A.V. Smith, *Opt. Commun.*, 32 (1980) 403.
- [15] T.W. Hänsch, D.R. Lyons, A.L. Schawlow, A. Siegel, Z-Y Wang, and G.-Y. Yan, *Opt. Commun.*, 38 (1981) 47.
- [16] M.L. Shah, P.K. Mandal, Vas Dev, and B.M. Suri, *J. Opt. Soc. Am. B*, 29 (2012) 1625.
- [17] L.F.M. Braun, and J.A. Lisbôa, *Opt. Commun.*, 108, (1994) 302.
- [18] D. Zhechev, and S. Atanassova, *Opt. Commun.*, 156, (1998) 400.
- [19] V.K. Saini, *Appl. Opt.*, 52, (2013) 4404.
- [20] Y. Oki, T. Izuha, M. Maeda, C. Honda, Y. Hasegawa, H. Futami, J. Izumi, and K. Matsuda, *Jap. J. Appl. Phys.*, 30 (1991) L-1744.
- [21] X. Zhu, A.H. Nur, and P. Mishra, *J. Quant. Spectrosc. Radiat. Transfer*, 52 (1994) 167.
- [22] S.G. Nakhate, M.A.N. Razvi, G.L. Bhale, and S.A. Ahmad, *J. Phys. B: At. Mol. Phys.*, 29 (1996) 1439.
- [23] A.K. Pulhani, M.L. Shah, Vas Dev, and B.M. Suri, *J. Opt. Soc. Am. B*, 22 (2005) 1117.
- [24] R.B. Green, R.A. Keller, G.G. Luther, P.K. Schenck, and J.C. Travis, *IEEE J. Quant. Electron.*, QE-13 (1977) 63.
- [25] Vas Dev, D.J. Biswas, and U. K. Chatterjee, *Appl. Phys. B* 50 (1990) 67
- [26] Vas Dev, U. Nundy, D.J. Biswas, U. K. Chatterjee and P.R.K. Rao, *B.A.R.C/I.993* (1990).
- [27] Y. Oki, N. Kidera, and M. Maeda, *Opt. Commun.*, 110 (1994) 105.
- [28] D.H. Katayama, J.M. Cook, V.E. Bondybey, T.A. Miller, *Chem. Phys. Letts.* 62 (1979) 542.
- [29] C. Delsart, J.C. Keller, C. Thomas, *J. Phys. B* 14 (1981) 3355.
- [30] R. Shuker, A. Ben-Amar, G. Erez, *J. Opt. Soc. Am.* 70 (1980) 1392.
- [31] A. Ben-Amar, G. Erez, S. Fastig, R. Shuker, *Appl. Opt.* 23 (1984) 4529.
- [32] B.R. Reddy, P. Venkateswarlu, M.C. George, *Opt. Commun.* 73 (1989) 117.
- [33] T. Awai, M. Kimura, *J. Phys. Soc. Jpn.* 59 (1990) 3807.
- [34] R. Khare, V.K. Saini, V.K. Shrivastav, U. Nundy, *Opt. Commun.*, 283 (2010) 542.